

# 一層平面配置圖

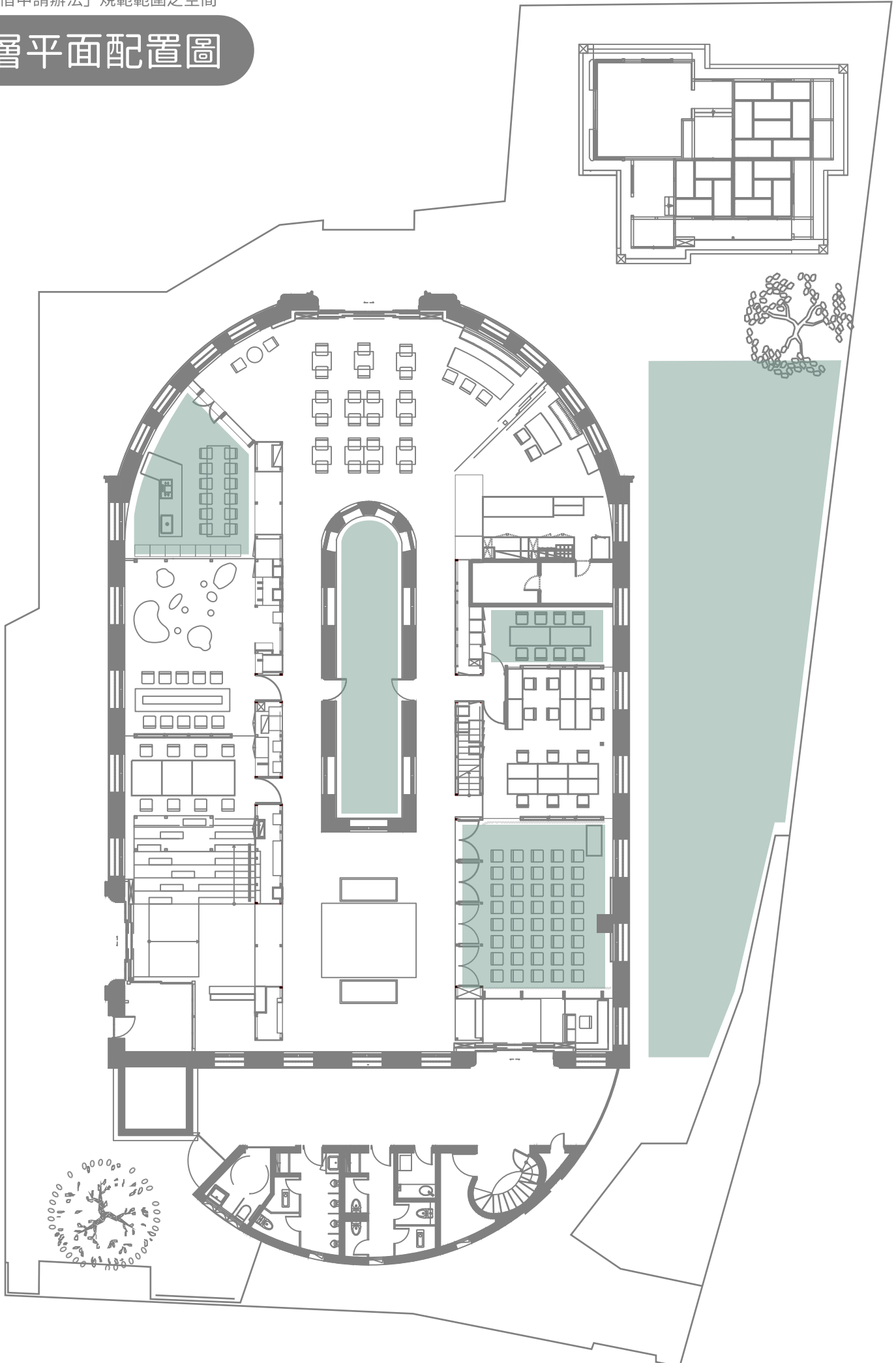

# 夾層平面配置圖

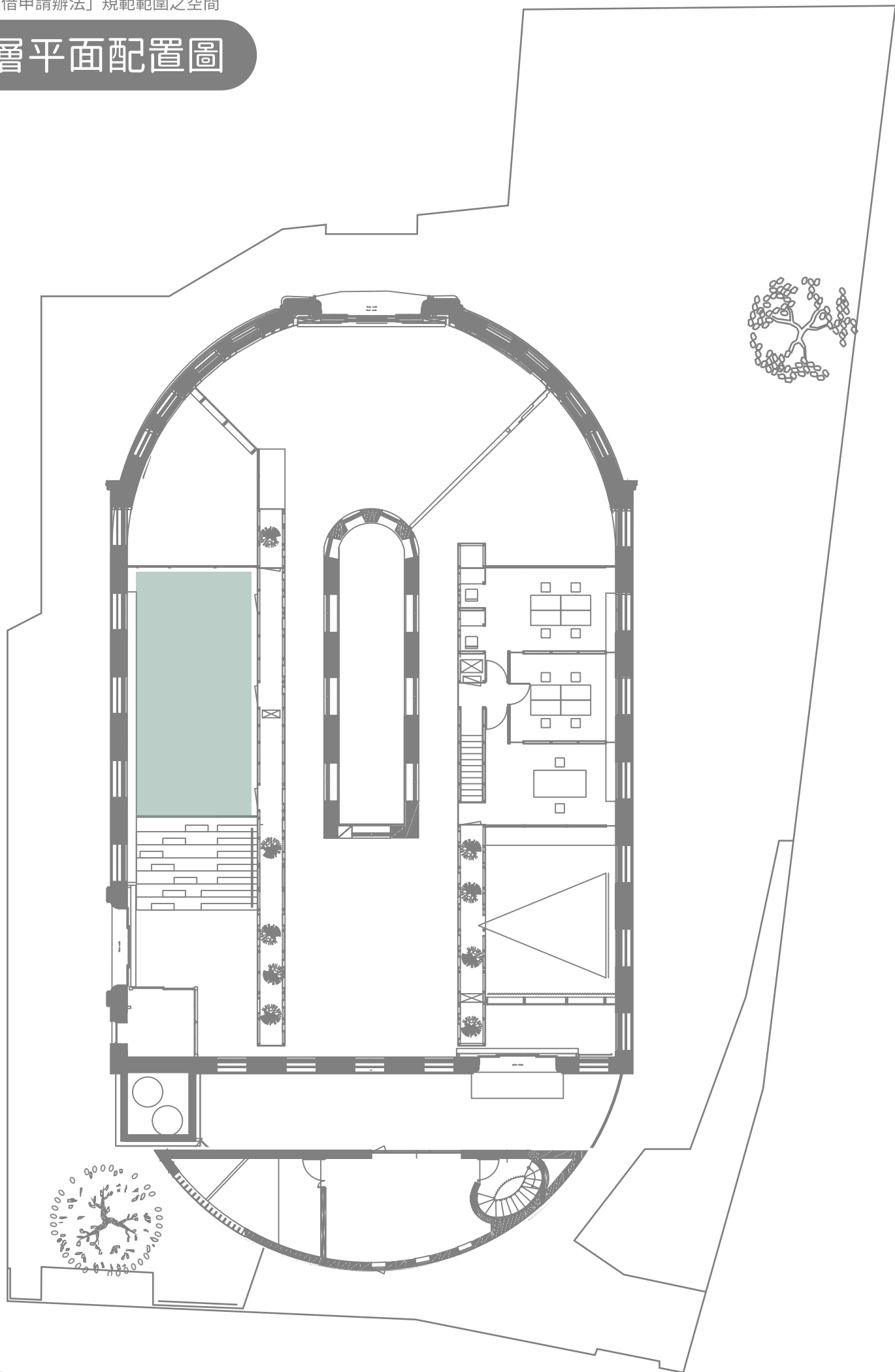

# 新富半樓仔

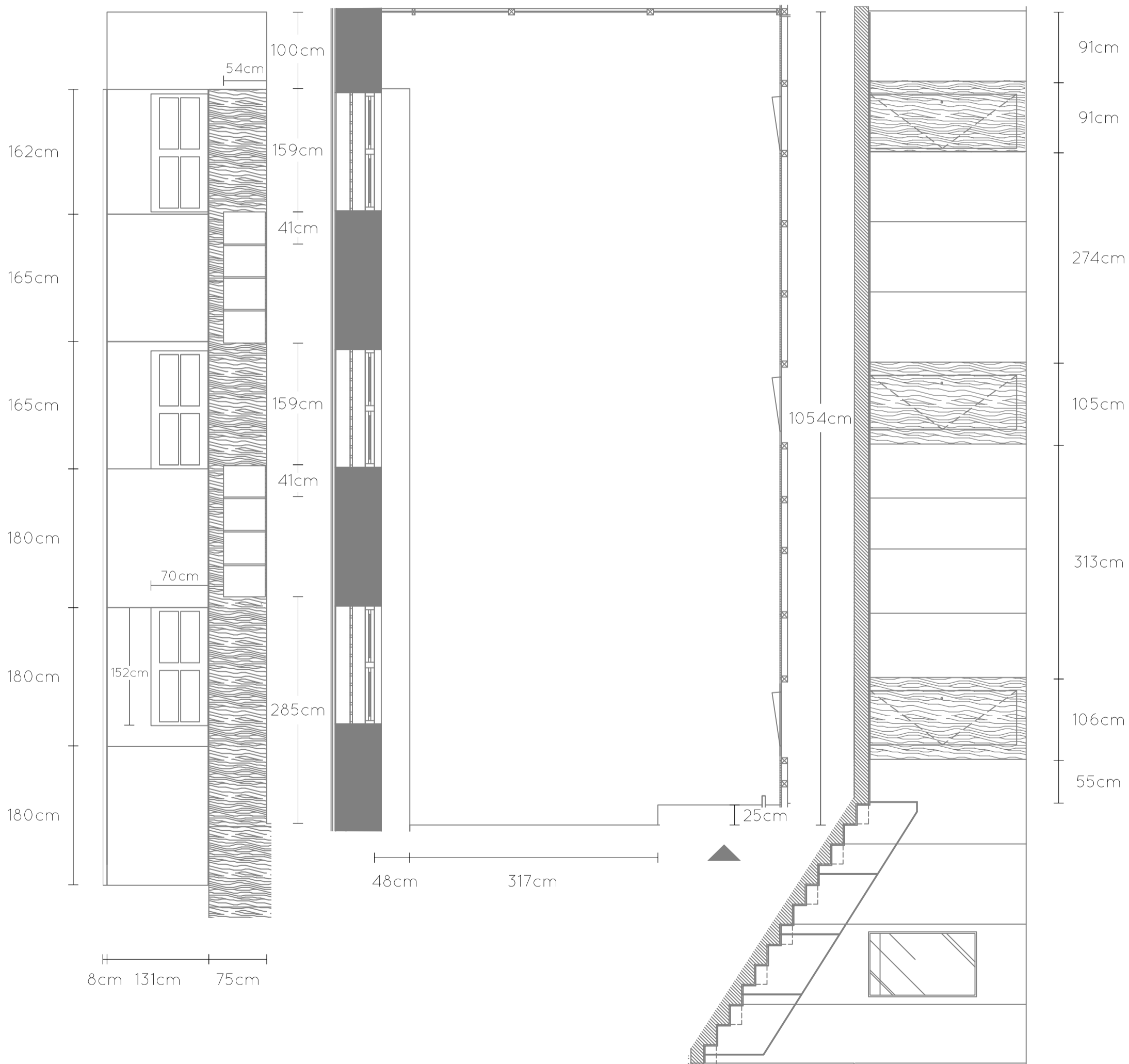
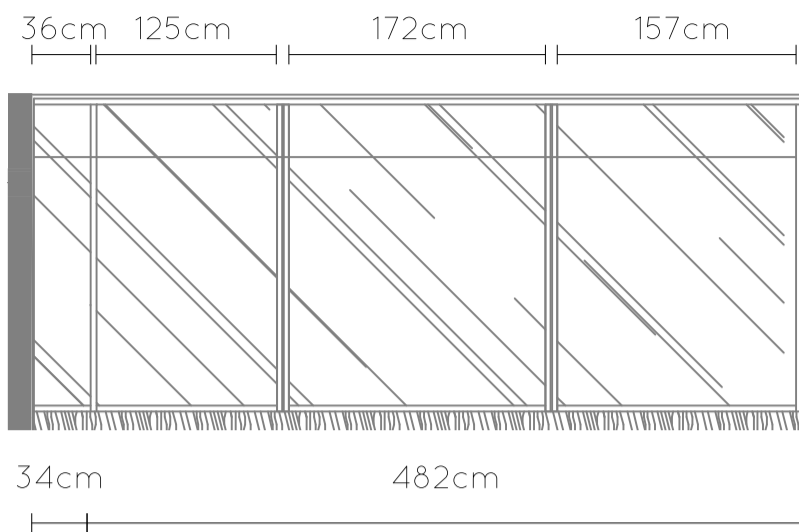
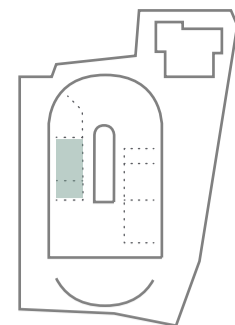

# 餐桌學堂

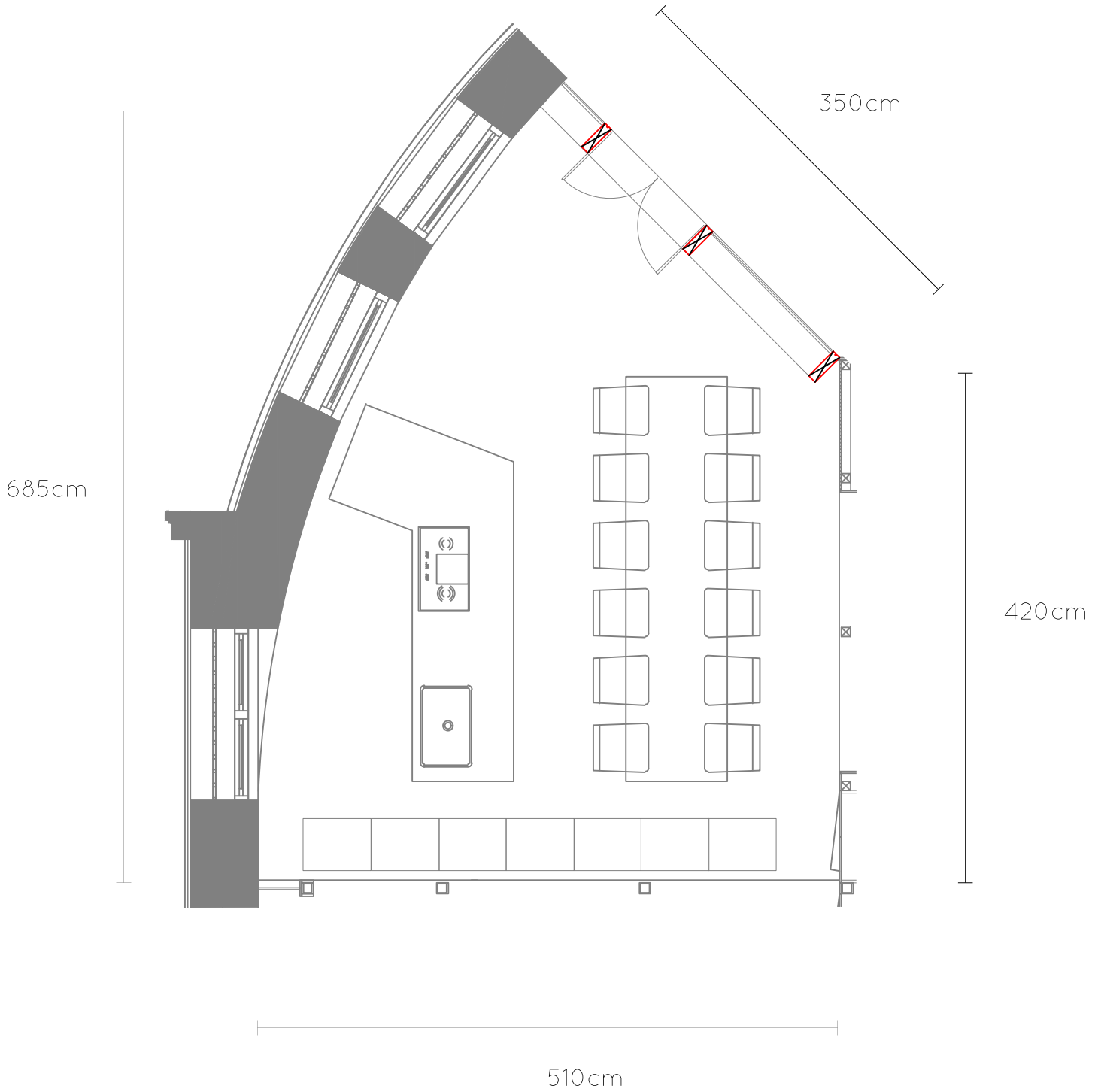
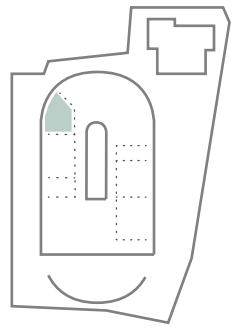

# 巷仔內教室

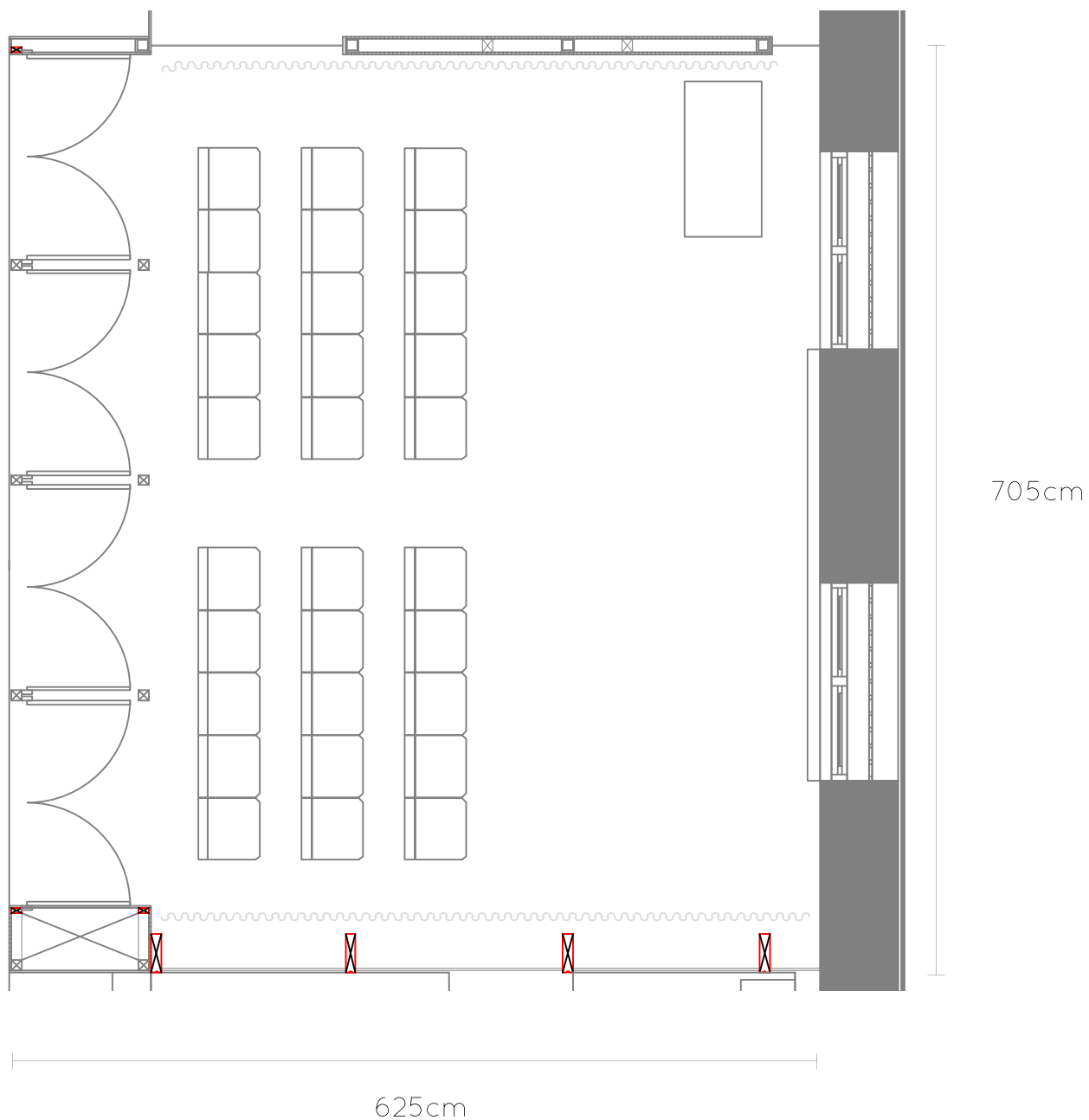
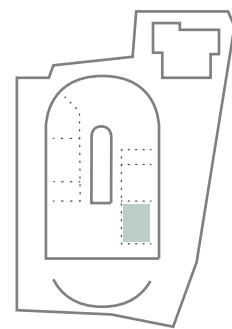

# 共同工作室

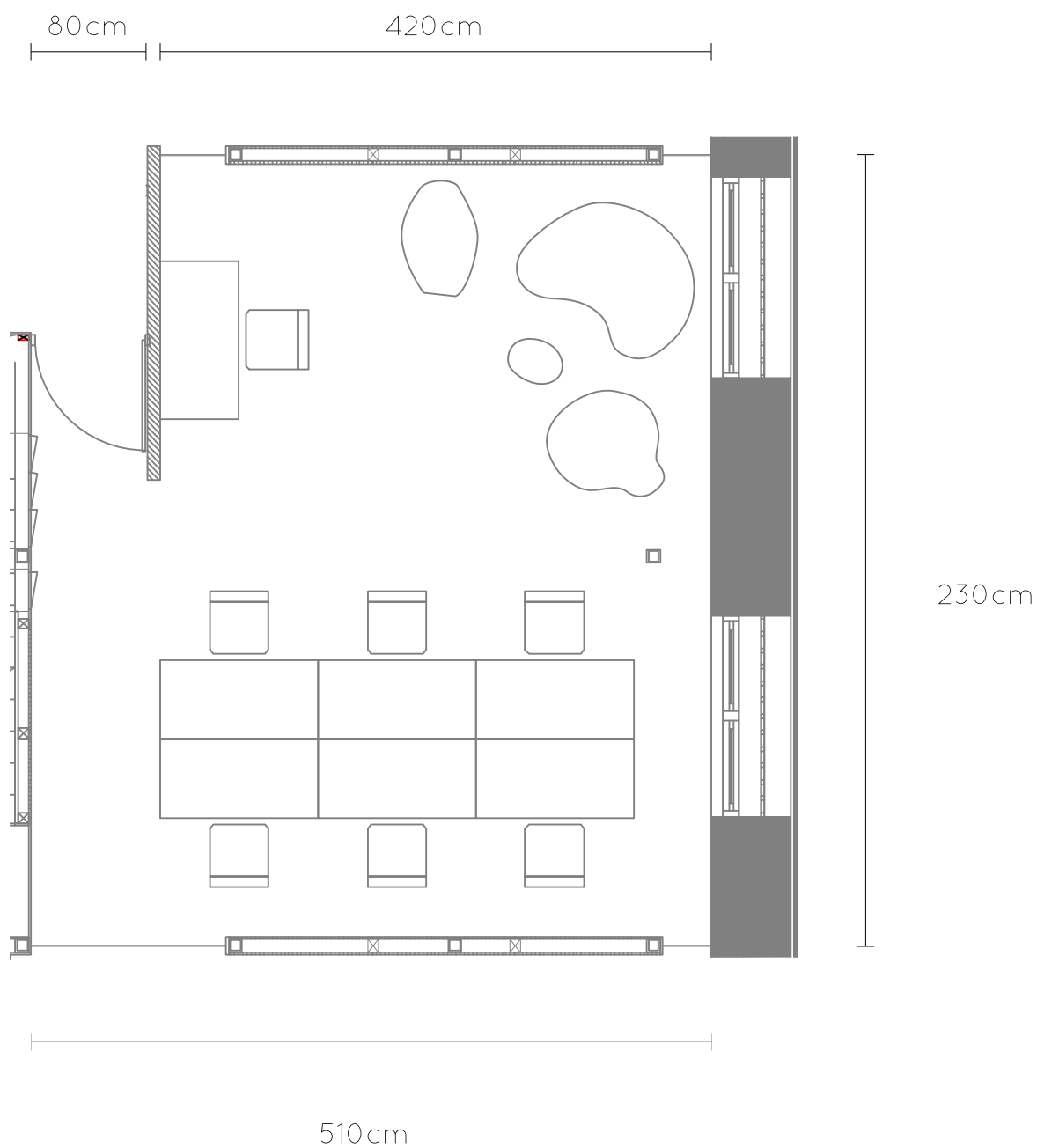
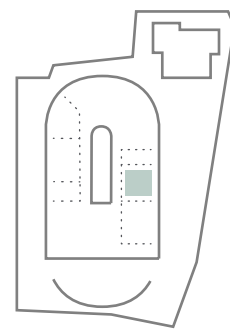

# 會議室

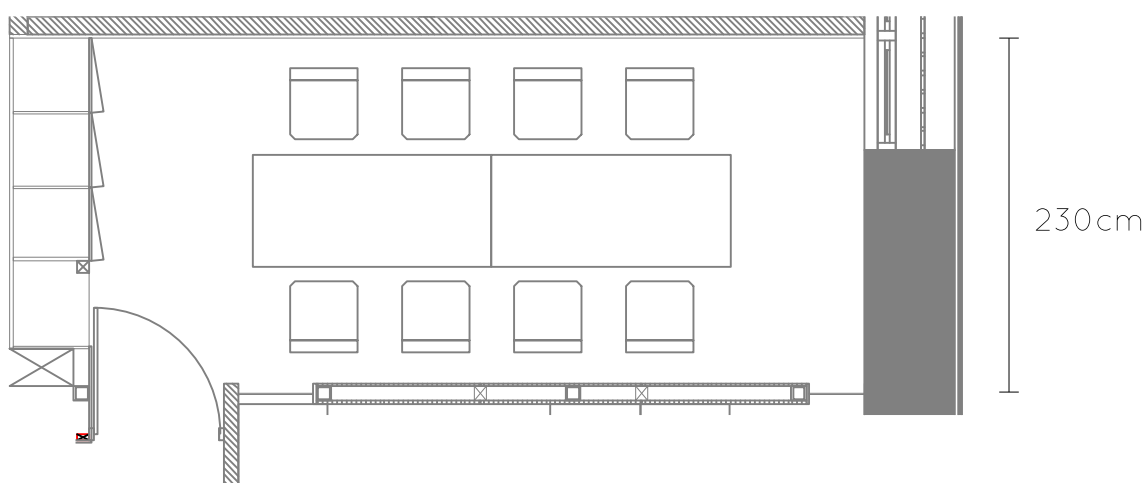
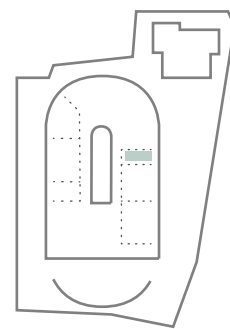

510cm



# 天井

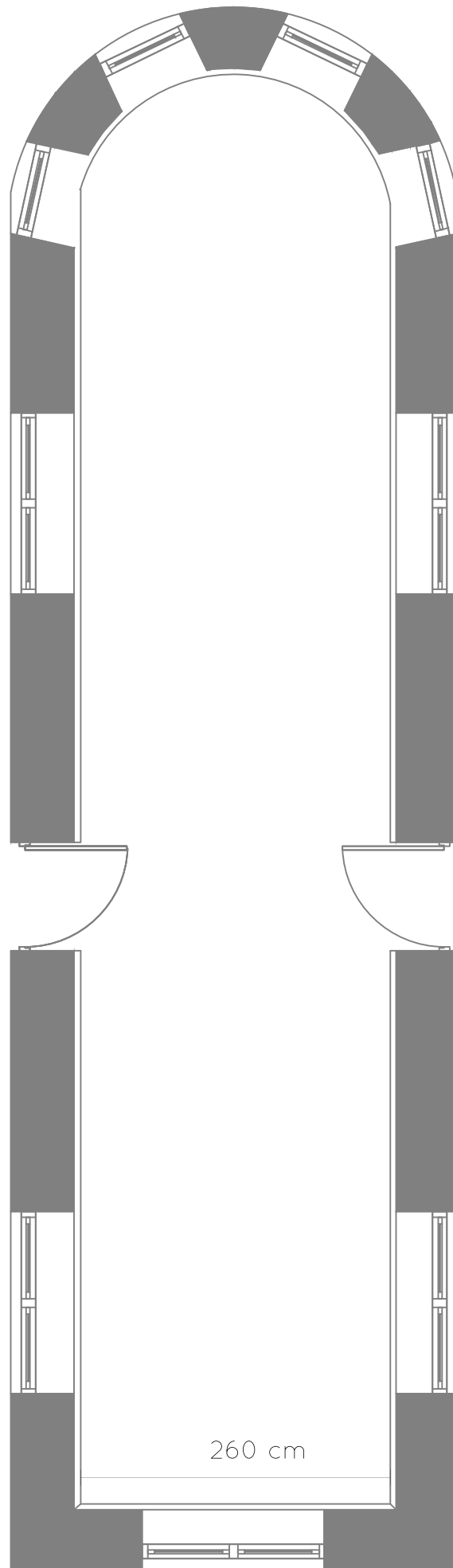
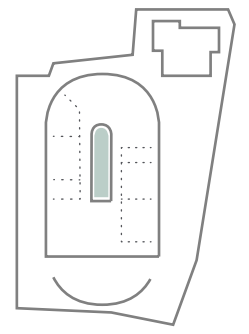

1200 cm

260 cm





# 廣場

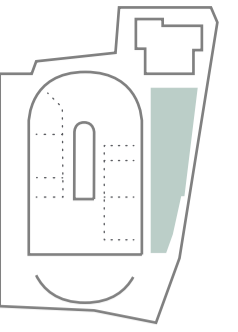
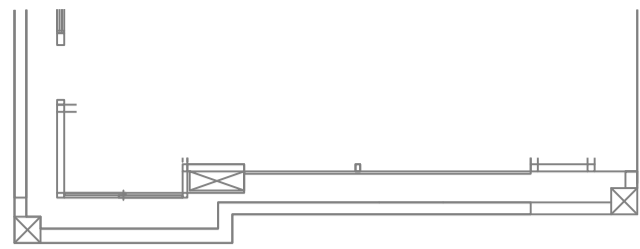
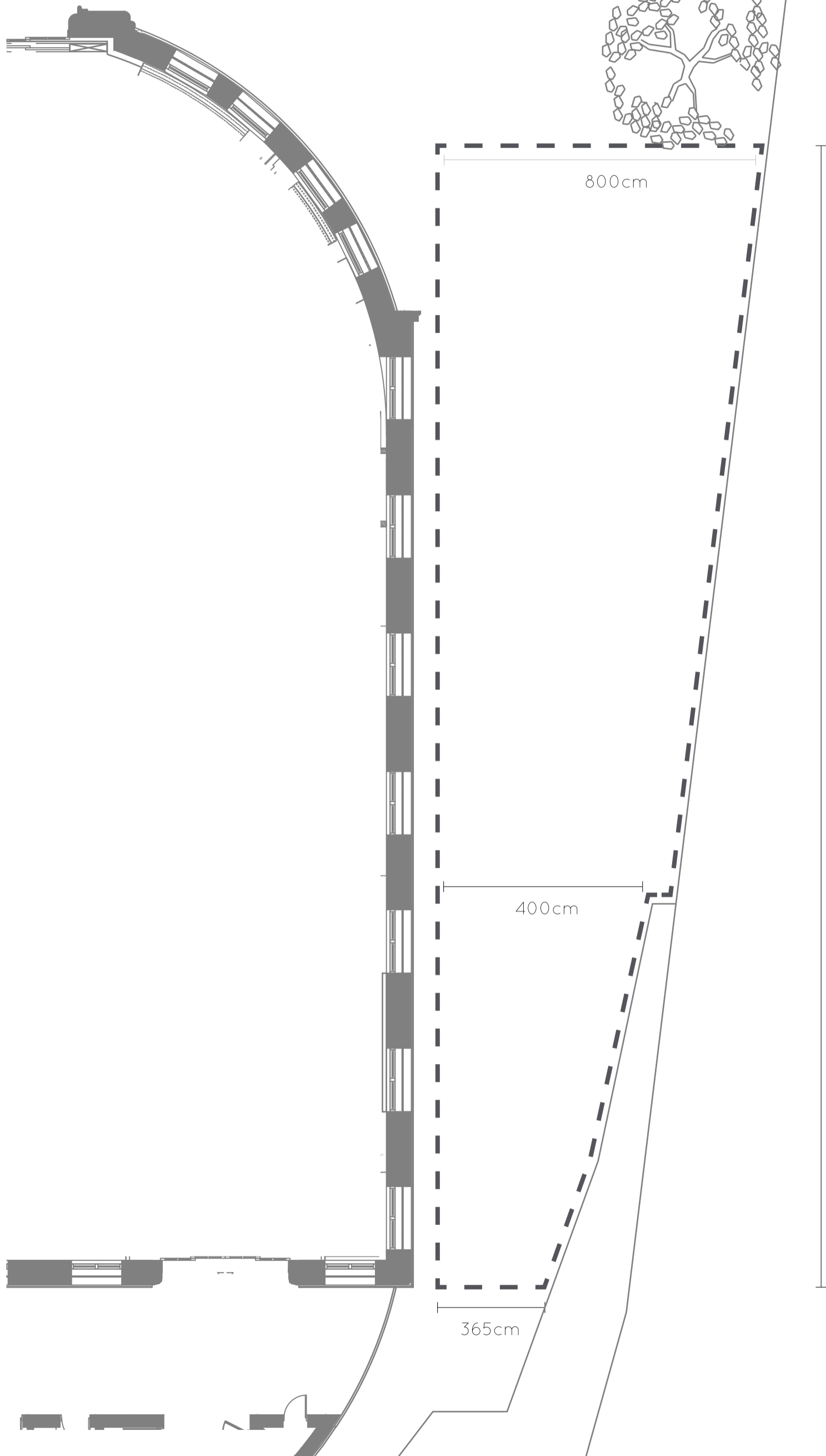

0 100 200 400 cm